

# Table of Contents

---

1	Important Safety Instructions	3
2	Package Contents	4
2.1	What's in your shipment	4
3	Assembly	5
4	Installation	8
5	Wiring	
6	Configuration	13
6.1	Connecting the Solar-Log to a network/PC	13
6.2	Setting up the Solar-Log® using the configuration Assistant	14
7	Appendix A: CT Placement	22

# 1 Important Safety Instructions

---

## Save These Instructions

The Solar-Log 2050 Assembly is used in conjunction with a Solar-Log® data logger that is capable of communicating with a wide variety of inverters, and one or several inverters of choice that can produce hundreds of AC current amps. These Safety Instructions are to help ensure safe installation and operation of the Solar-Log 2050 and the equipment it is connected to. Be sure to read the instructions which came with the Solar-Log 2050 and all other connected equipment carefully. Inspect the Solar-Log 2050 and all other equipment and read all cautionary and instructive markings on all equipment. Be sure to follow all cautions and instructions when installing all equipment. Save this manual, it has important maintenance and operation information.

Proper equipment grounding must be performed as directed in the grounding section of this manual.

THIS IS THE SYMBOL FOR GROUND: 

THIS IS THE SYMBOL FOR DIRECT CURRENT (DC): 

THIS IS THE SYMBOL FOR ALTERNATING CURRENT (AC): 

- Use appropriate size conductors rated for at least 90°C.
- Torque all connections as recommended in this manual.

Solar Data Systems, Inc. requires that all wiring must be done by a licensed electrician or certified technician in accordance to all local and national electrical codes applicable in your jurisdiction. Do not perform electrical work without the proper qualifications.

To avoid a risk of fire and electric shock, make sure that existing wiring is in excellent condition and that the conductors are correctly rated. Do not operate any system components with damaged or substandard conductors. Use only attachments recommended or sold by Solar Data Systems, Inc. or our Authorized Distribution Partners. Attaching other devices may result in a risk of fire, electric shock, or injury to persons. **To reduce the risk of electrical shock, disconnect all sources of AC and DC power from the Solar-Log 2050 before removing the cover and attempting any maintenance or working on any components connected to the Solar-Log 2050.**

## Intended Use

The Solar-Log 2050 is designed for use only with Solar Data Systems, Inc. equipment. Any inappropriate application may result in a fire hazard or personal injury.

## Warning

The Solar-Log 2050 is designed for indoor or outdoor use. The enclosure is rated IP66 which offers resistance to dust and sprayed water infiltration. It must be installed using the proper fittings to maintain this rating. Failure to do so in damp environments will significantly shorten the life of this product and may affect the product warranty.

Do not mount the Solar-Log 2050 Enclosure in an area exposed to direct sunlight. It must be placed in a constantly shaded area.

Do not disassemble the Solar-Log 2050. The Solar-Log 2050 does not have any user-serviceable parts.

Always use insulated tools to reduce the chance of short-circuits when installing or working with power connections, PV arrays and any other connected equipment. To further reduce the risk of exposure to live circuits remove all jewelry while installing this system.

## 2 Package Contents

---

### 2.1 What's in your shipment



Figure 2.1: Solar-Log 2050, Current Transformers (CTs), Solar-Log Base or Solar-Log 50 Gateway

#### The shipment comes with the following components:

- Solar-Log 2050 (art. no. 840850): In an indoor/outdoor enclosure, the assembly includes a revenue grade meter, power supply, fusing blocks, shorting blocks, RS485/422 ports
- Current Transformers (CTs) models and number of units vary
- One of the following Solar-Log® models: Solar-Log Base 100 (art. no. 256326), Solar-Log Base 2000 (art. no. 256327), or Solar-Log 50 Gateway (art. no. 256200)

#### Note:

If you are using the Solar-Log 2050 assembly for consumption monitoring only, the Solar-Log Base or Solar-Log 50 might not be included in your shipment.

The Solar-Log 2050, Solar-Log Base/Solar-Log 50, and CTs are all sold separately.

### 3 Assembly

1. Remove the front cover on the Solar-Log 2050 enclosure by unscrewing the 4 plastic captive screws.



Figure 3.1: Open Solar-Log 2050

3. Clip the Solar-Log Base or Solar-Log 50 to the DIN rail as seen in the image below.

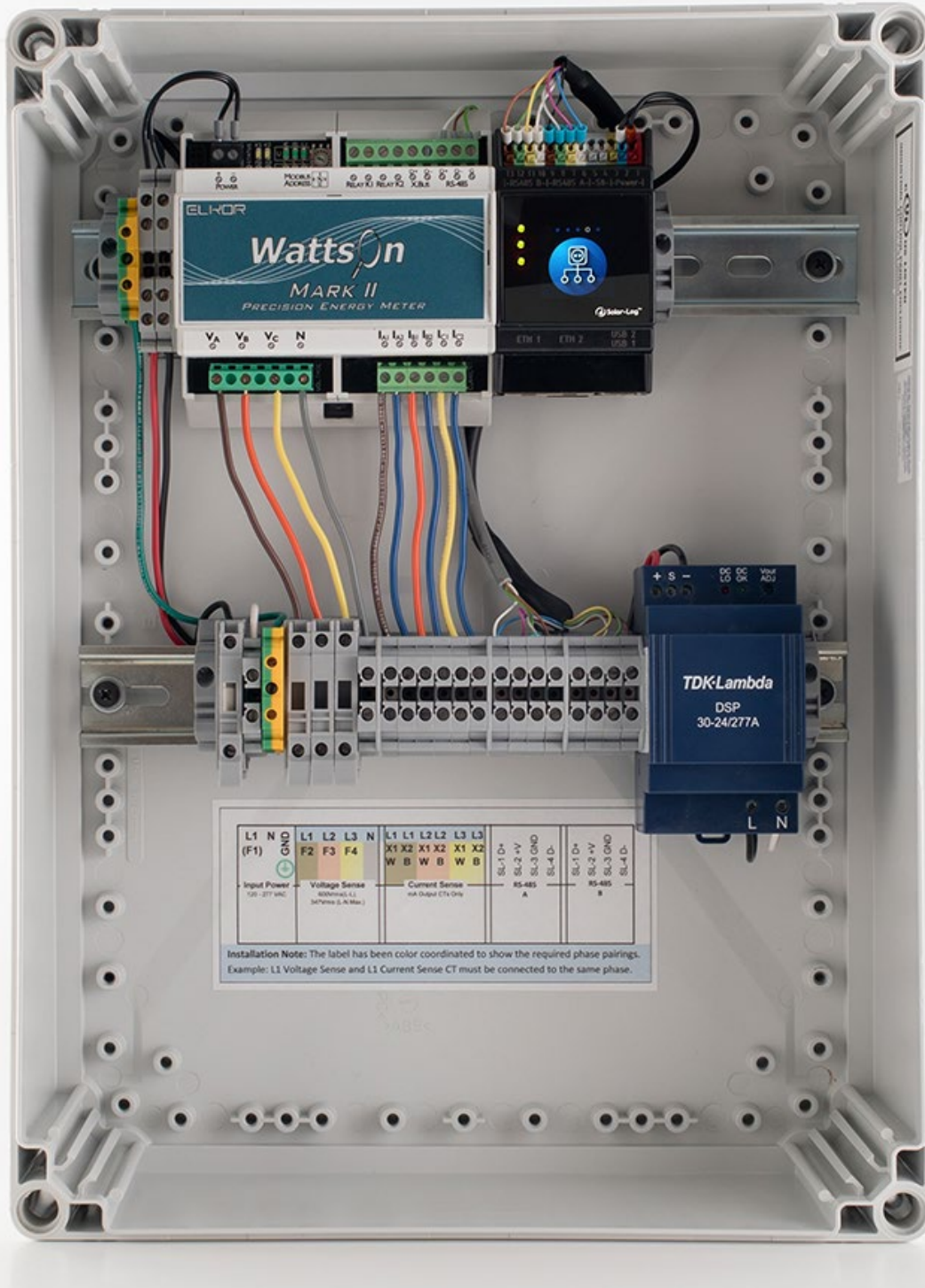

Figure 3.2: Solar-Log Base mounted to the Solar-Log 2050

4. Connect the DC Power, Port A & Port B connectors to the Solar-Log Base or Solar-Log 50 (Figure 3.3).



Figure 3.3: Logger Connections

## 4 Installation

---

1. Select a suitable wall location and use suitable rustproof screws to secure the Solar-Log 2050 unit to the support. Different anchors and screws for fitting the Solar-Log 2050 box are required depending on the support. Therefore, anchors and screws for mounting are not supplied (Figure 4.1).

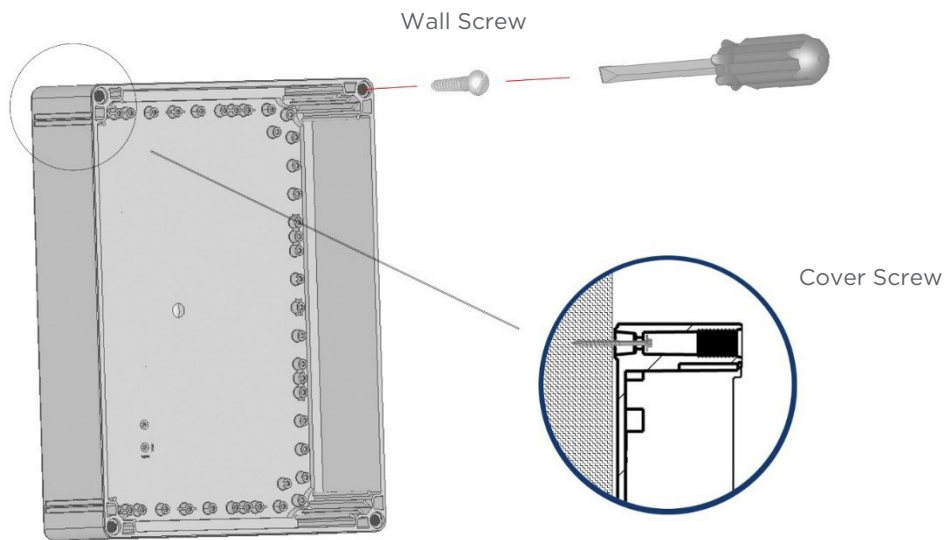

Figure 4.1: Mounting Instructions

2. Drill the needed conduit holes for mains power and other connections. Run power mains and communication lines in separate conduit.

**Note: DO NOT DRILL OR SCREW DIRECTLY INTO THE ENCLOSURE!** In order to keep the enclosure waterproof and maintain its environmental (IP) ratings please use the 4 pre-drilled mounting/lid holes for fastening the enclosure to the wall.



# 5 Wiring

---

**Note:**

Before you start wiring make sure the system is de-energized. Refer to Figures 5.3 & 5.4:

1. Connect the input power to F1 (line) and N (Neutral) and GND (Ground). Torque F1 to 17.7 in-lbs. (2Nm), and N and GND to 5.3 in-lbs. (0.6Nm).
2. Connect the 3 phase voltage sense wires to F2 (L1), F3 (L2), F4 (L3), and N (Neutral). Torque F2 - F4 to 17.7 in-lbs. (2Nm), and N to 5.3 in-lbs. (0.6Nm).
3. Install current transformers (CTs) on the mains voltage feed wires. Refer to CT labeling for Source/Load direction and see Appendix A.
4. Connect the CT sense wires to the appropriate terminals. Torque terminal connections to 5.3 in-lbs. (0.6Nm).

**Note:**

Connect the CT X1 wire to the X1 terminal and the X2 wire to the X2 terminal. The CT sense wires may be extended, as necessary. Splice 18 AWG hookup wires and minimize wire extension length to limit additional impedance on the circuit.

**Note:**

For 5A CT systems only: When the CT wires are in place on the short blocks (Figure 6) you must now lower the orange tab over the screw terminals. This prevents access to the circuit with a screwdriver, as well as completes the circuit. Unscrew both the screws near the "I" and pull the orange bar over the screw terminals. Re-fasten the screw closest to the "I". The circuit is now complete. The meter must NOT be disconnected when the shorting block is in the OPEN position.

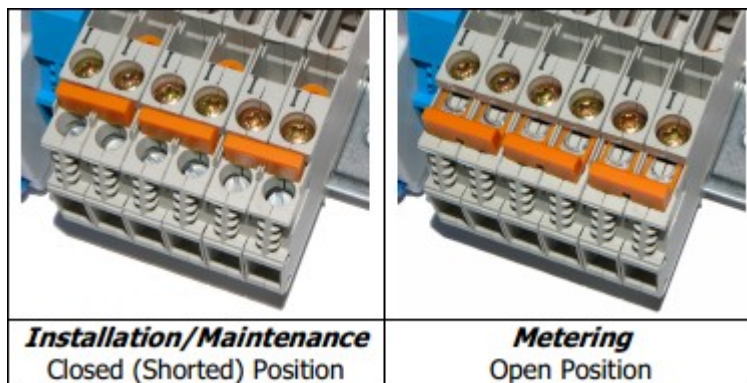

Figure 5.1: CT Shorting Block

5. The RS-485 connections between the Solar-Log® and Revenue Grade Meter are pre-wired. Connections to the Inverter(s) are made to the RS-485 Port B terminals at the right side of the enclosure. Torque terminal connections to 5.3 in-lbs. (0.6Nm).
6. Power the enclosure and wait for the Solar-Log® to complete its booting process.



Figure 5.2: Elkor Meter LEDs

7. For 3 phase systems, six green LED's on the WattsOn meter should be solid (exception: bi-directional meter). If any of the green LED's in the bottom row are blinking the CT is in the wrong direction. Flip the CT or the wire leads in the terminal block. If any of the six LED's are red (solid or blinking) then the CT and voltage tap are phase mismatched. Swap CT leads in terminal blocks till all six lights are green.

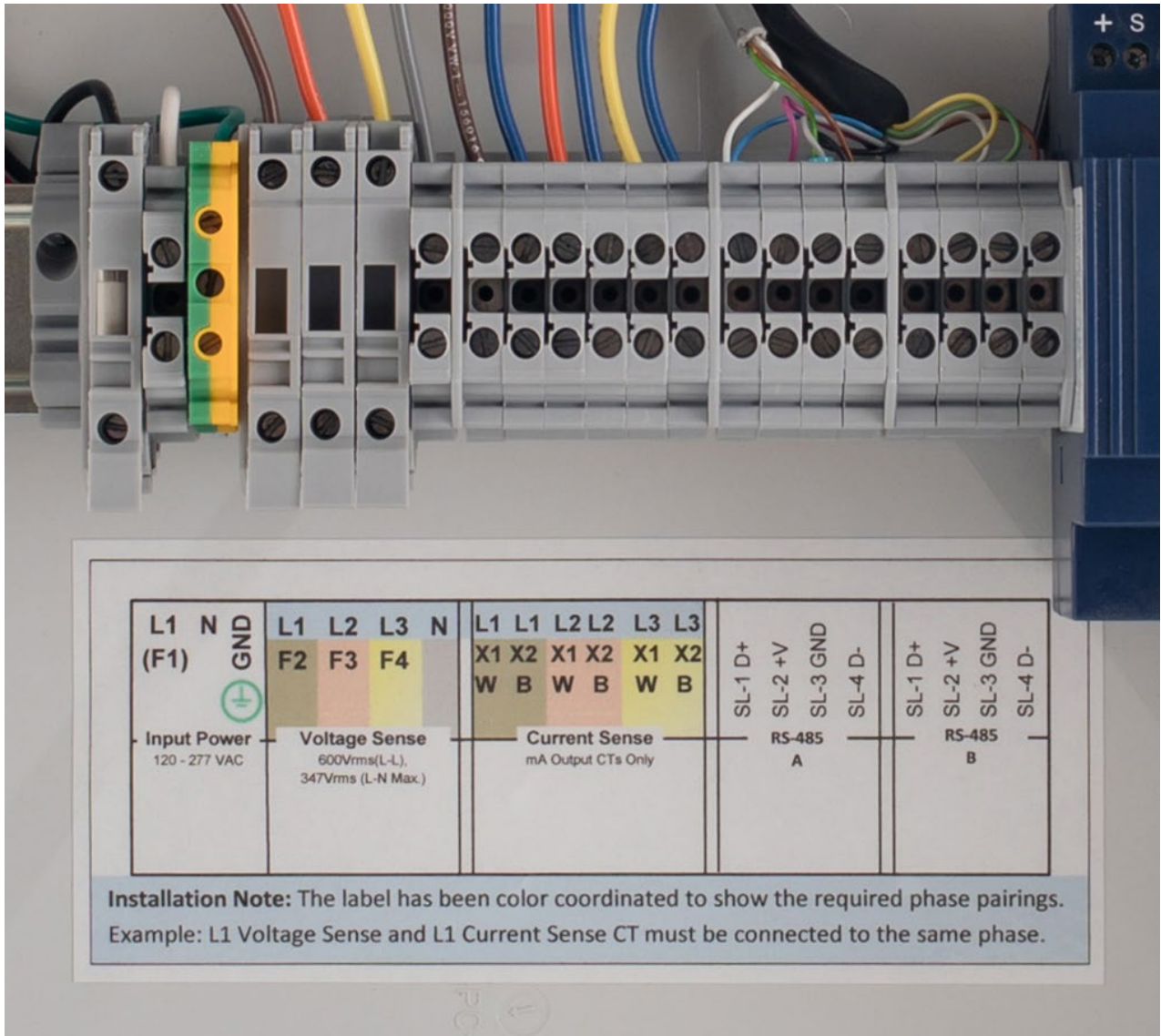

Figure 5.3: Wiring Compartment

**Note:**

CT lead wire color can vary. Verify lead color of CT in manufacturer manual. Terminals L1-L3 for mA meters are equipped with standard terminal blocks instead of shorting blocks.

SOLAR-LOG BASE WITH THREE PHASE WIRING DIAGRAM AND ENERGY METER

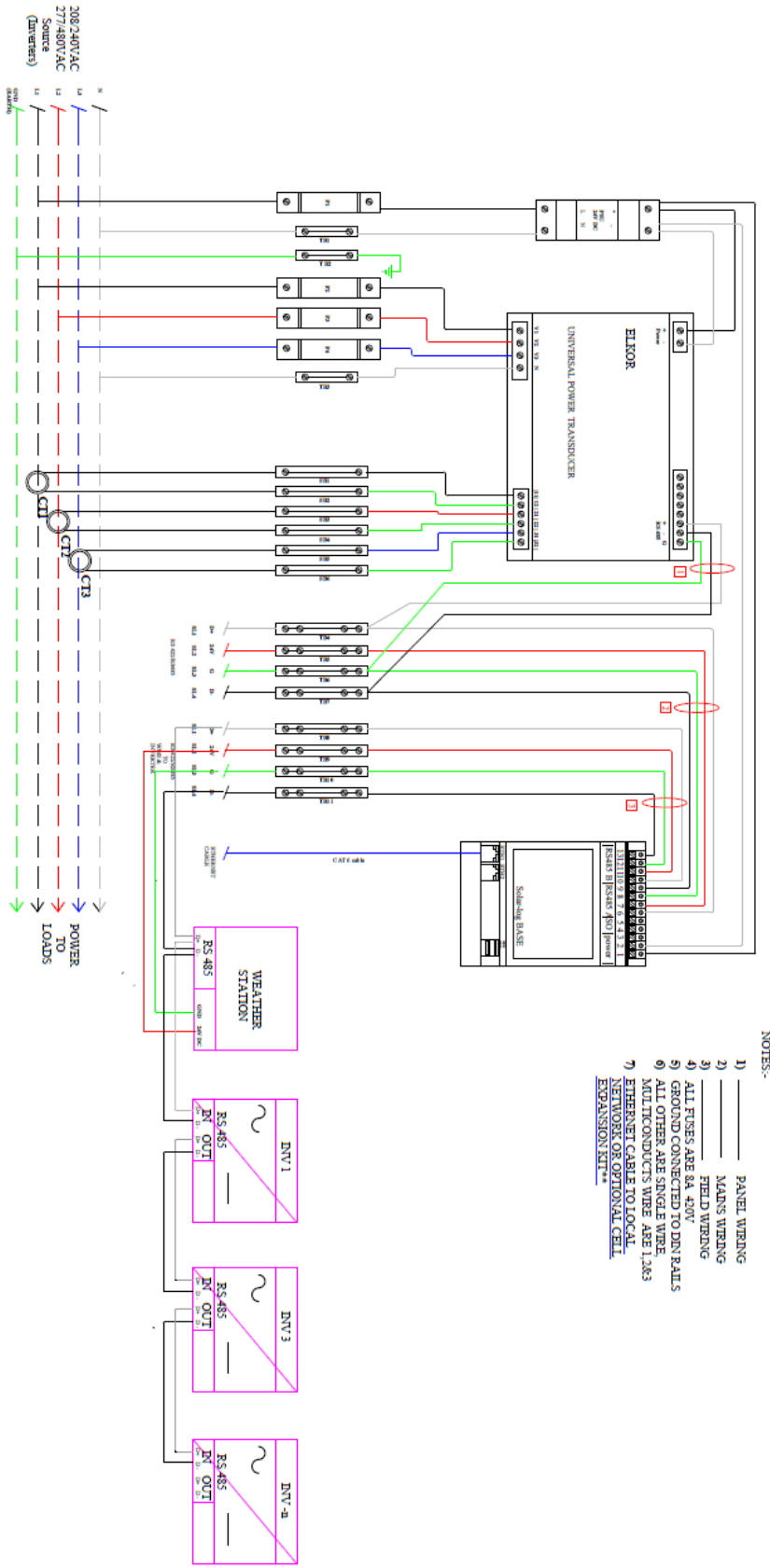

Figure 5.4: Three Phase Wiring Diagram

# 6 Configuration

---

- The Solar-Log® has an integrated web server, which contains all the software necessary for operation and configuration.
- No additional software needs to be installed on the PC to access the Solar-Log®. A common web browser with JavaScript enabled is required. We recommend using the current version of Mozilla's Firefox or Google's Chrome.
- To run the web browser, a network connection is required between the PC and Solar-Log®, and Solar-Log® must be up and running. It is recommended to have DHCP enabled on the router.

## 6.1 Connecting the Solar-Log® to a network / PC

The Solar-Log® is equipped with a standard Ethernet RJ45 socket, which can be connected through any commercially available network cable. Speeds of 10 Mbit and 100 Mbit are supported. In general, any PC networking technology can be used for connecting the Solar-Log®. The following technologies are available:

- Connection through an Internet router Ethernet RJ45 network cable (This is the preferred method).
- Direct cable connection from PC to Solar-Log® Ethernet RJ45 network patch cable. If connecting directly to a PC, the cable must be the crossover network cable type (patch cable).

**Note:** A crossover cable may not be necessary if using a newer Laptop with Autosense.

### Device URL

- Start the web browser.
- Enter `http://solar-log` in the address window and press the ENTER key.
- The main menu of the Solar-Log® is displayed.

### Device URL when there are several Solar-Log® devices on the network

- Start the web browser.
- Enter `http://solar-log-wxyz` in the address bar and press the ENTER key: Here wxyz stands for the last 4 digits from serial number of the Solar-Log®. The serial number is printed on the model tag.
- The main menu of the Solar-Log® is displayed.

## 6.2 Setting up the Solar-Log® using the Configuration Assistant

### Initial Setup



Welcome to the main menu  
of the Solar-Log Base 2000



Language

English - English



Die Einstellungen wurden noch nicht gespeichert.

NEXT

1. Select the correct language. Then Select NEXT.

Country

United States

Time

Date / Time (currently) 23.04.20 22:35:21

Date / Time (new)

SET

Timezone GMT -5:00

Day Light Saving Time settings US/Canada DST Rules

Automatic time synchronization

Activated

Start time synchronization with the NTP server now

START

The changes have not been saved.

BACK NEXT

2. Select the Country
  - a. Set the Date / Time. Note the format is MM.DD.YY HH:MM:SS.
  - b. Select SET and verify the time Date/Time (currently) is now correct.
  - c. Set the Time Zone (EST= -5:00, CST = -6:00, MST = -7:00, PST = -8:00, HST = -10:00).
  - d. Set the Day Light Saving Time Settings to either US/Canada DST rules or None.
  - e. Select NEXT.

Browser access control

Password required for user access  Deactivated

User password

Repetition

Password required for installer access  Deactivated

Installer password

Repetition

Password required for installer/PM access  Deactivated

Installer password

Repetition

The changes have not been saved.

BACK NEXT

3. Set the password for the installer and/or the user if it is desired. Otherwise, set the Password required to **Deactivated** to disable password protection of the local interface. Then select **NEXT**.

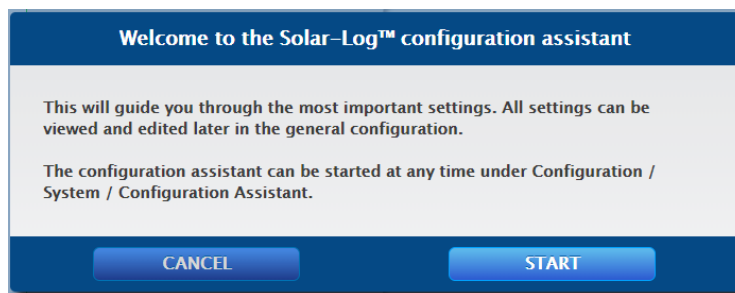

4. Select **START** to begin the Configuration Assistant.

## Configuration Assistant

The screenshot shows the Configuration Assistant interface. It is divided into two main sections: Interface ETH 1 and Interface ETH 2.

**Interface ETH 1**

- Obtain IP address automatically (DHCP):** A toggle switch is currently turned on, labeled "Activated".
- IP address:** A text input field contains "192.168.23.102".
- Subnet mask:** A text input field contains "255.255.255.0".
- Gateway:** A text input field contains "192.168.23.254".
- DNS server via DHCP server:** A text input field contains "192.168.23.4, 75.75.75.75, 4.2.2.2".
- Primary DNS server:** A text input field contains "8.8.8.8".
- Secondary DNS server:** A text input field contains "8.8.4.4".
- Internet connection:** A blue button labeled "CONNECTION TEST" is visible.

**Interface ETH 2**

- Enable interface:** A toggle switch is currently turned off, labeled "Deactivated".

A blue "NEXT" button is located at the bottom right of the configuration window.

1. Set obtain IP address automatically (via DHCP) to Activated or Deactivated to enter a static IP address.
2. Select CONNECTION TEST and the Logger will test the internet connection. This will take a few minutes.

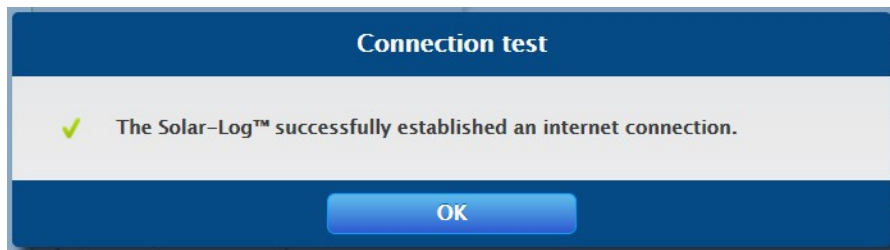

3. Connection Test: If you get the above screen your internet settings are correct & you may continue by selecting OK.





4. Firmware-Update: Select NO. Upgrades can be done at later time.

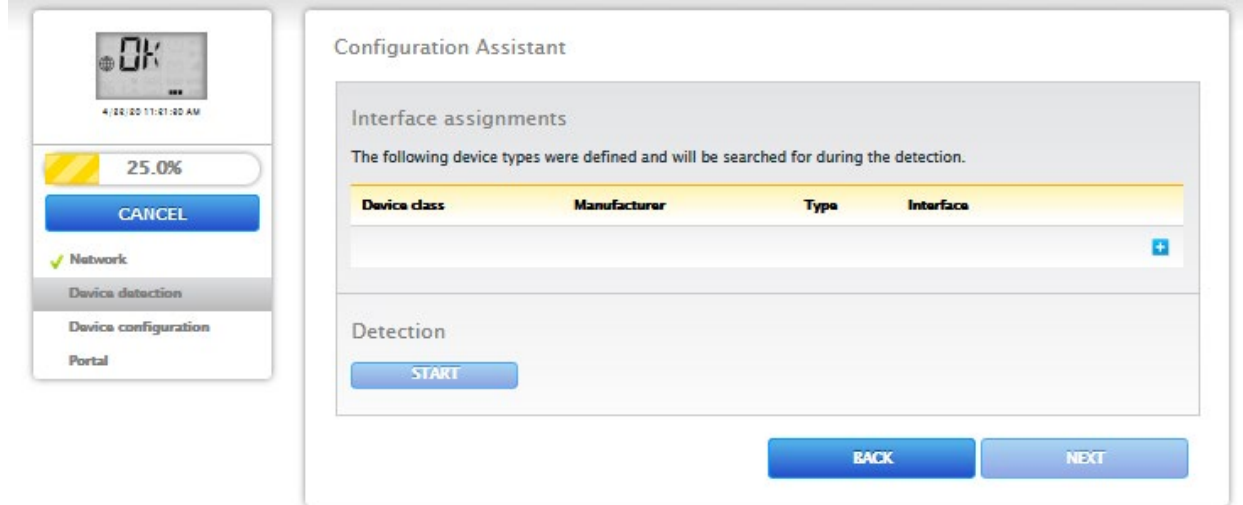

5. Select the Blue + on the right side of the screen.

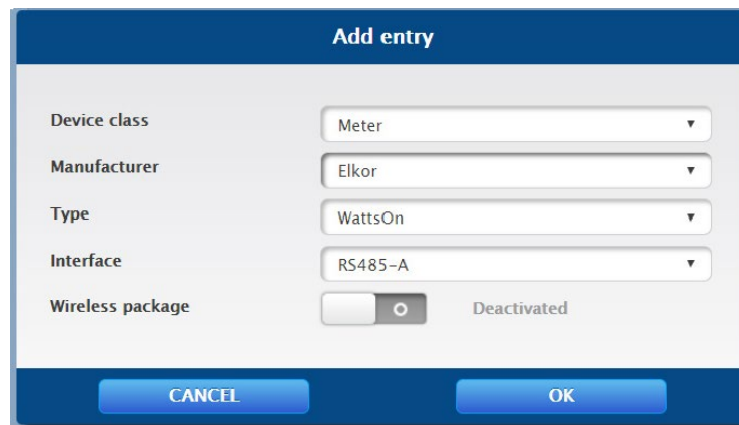

6. Set Device Class to Meter and fill in the information as shown above. Then select OK.

**Note:** Add any additional components that the Solar-Log® is to communicate with. Refer to [Solar-Log-America.com](http://Solar-Log-America.com)>Support>Supported Components to get the settings.

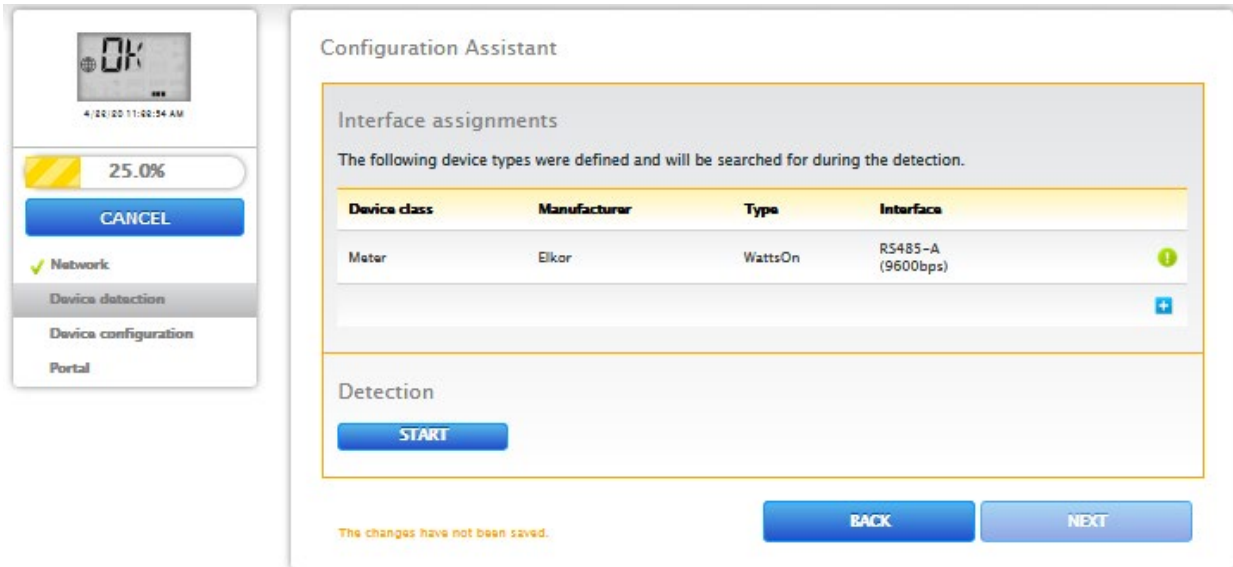

7. Select **START** to begin searching for the defined components.

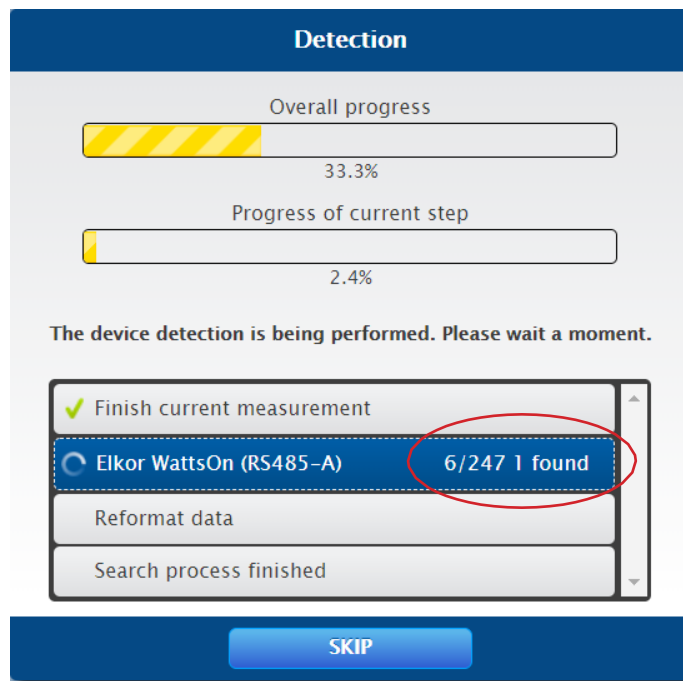

8. When the 1 Found is displayed you can select **SKIP** to continue to the next step in the process.

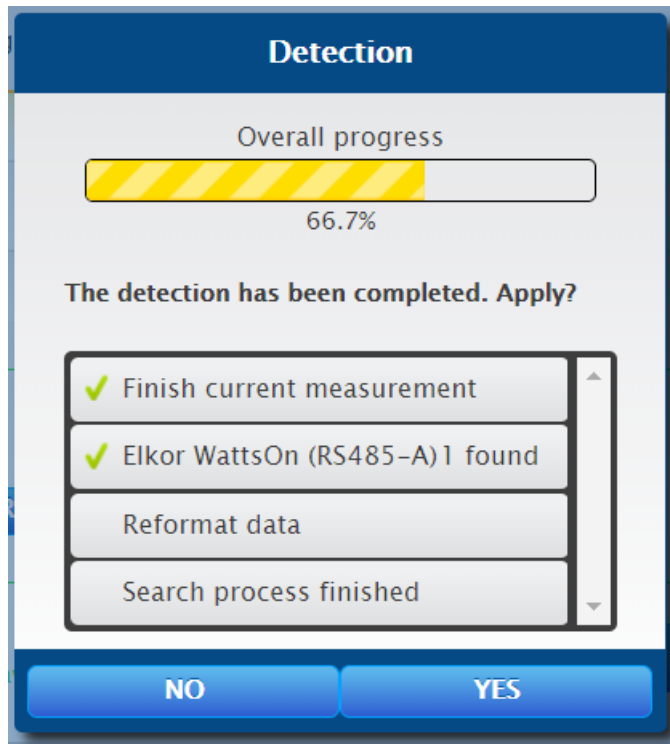

9. Click YES to apply the changes.

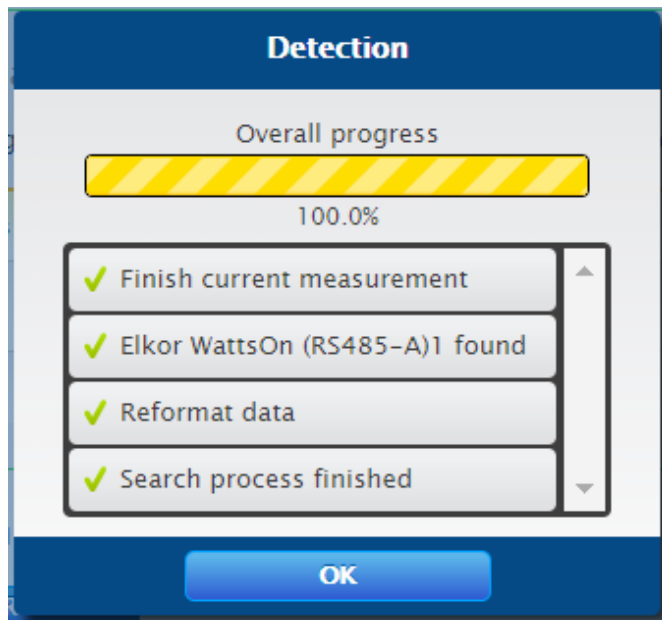

10. Click OK.

### Configuration Assistant

Interface assignments

The following device types were defined and will be searched for during the detection.

Device class	Manufacturer	Type	Interface
Meter	Elkor	WattsOn	RS485-A (9600bps)

Detection

**START**

**BACK** **NEXT**

11. Select NEXT.

50.0%

**CANCEL**

- ✓ Network
- ✓ Device detection
- Device configuration
- Portal

### Configuration Assistant

Device configuration

Device: 1: INV 1 ?

Model: Elkor MKII-mA

Address / serial number: 1/13375

---

Meter configuration

Operating mode: Total plant meter ?

CT current: 37500000

---

Module field, power & label

Name: Solar Meter

Generator Power: 100000 Wp

Module field: 1 ▼

The changes have not been saved.

**BACK** **NEXT**

- Verify that the Operating mode is set to Total plant meter.
- If your system is using CT's with the part # MRA-75 or MRS-125 or MRA-2x3 on the label set the CT current to 37500000. For all other CT models contact Solar-Log® Technical Support for assistance.
- Set the Name to Solar Meter.

15. Enter the DC watts of the whole plant (Watts per panel x # of panels).
16. Select NEXT.

The screenshot shows the Configuration Assistant interface. On the left, a progress bar is at 75.0%. Below it are three checked items: Network, Device detection, and Device configuration. The Portal section is currently active. The main area is titled 'Configuration Assistant' and 'Solar-Log WEB Enerest™'. It features a toggle for 'Activate transfers' which is set to 'Activated'. Below that is a text field for 'Portal Server' containing 'YourPortalName.solarlog-web.net'. At the bottom, there is a message 'The changes have not been saved.' and two buttons: 'BACK' and 'NEXT'.

17. Set Activate transfers to Activated.
18. Enter the correct portal server for you company i.e., xxxxx.solarlog-web.net
19. Select NEXT.

The screenshot shows the Configuration Assistant interface at 100.0% completion. The progress bar is now full. The checked items on the left now include 'Portal'. The main area is titled 'Configuration Assistant' and 'Congratulations!'. A message states: 'You have made the most important settings for your Solar-Log™. All settings can be viewed and edited later in the general configuration.' Below this, there are two sections: 'Detected devices' and 'Data transfers'. The 'Detected devices' section shows 'Power meters' with the value 'RS485-A: 1 x Elkor WattsOn'. The 'Data transfers' section shows 'Portal transfer' with the value '4/20/20 12:01:01 AM - OK'. At the bottom, there are two buttons: 'BACK' and 'FINISH'.

20. Select FINISH to complete the configuration.

Congratulations you have completed the installation!

## 6 Appendix A: CT Placement

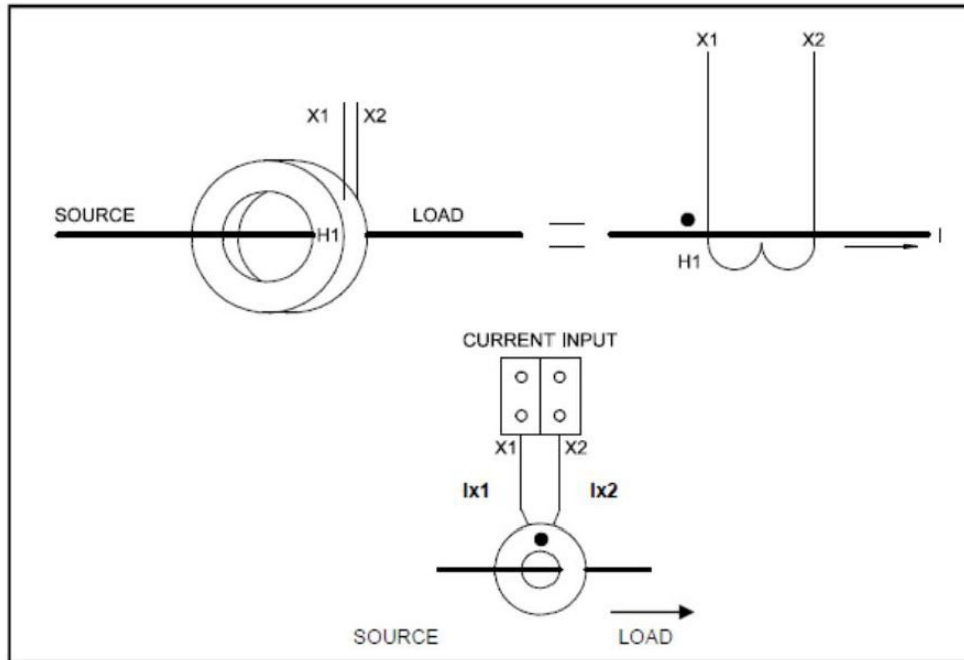

Figure A.1: CT Installation

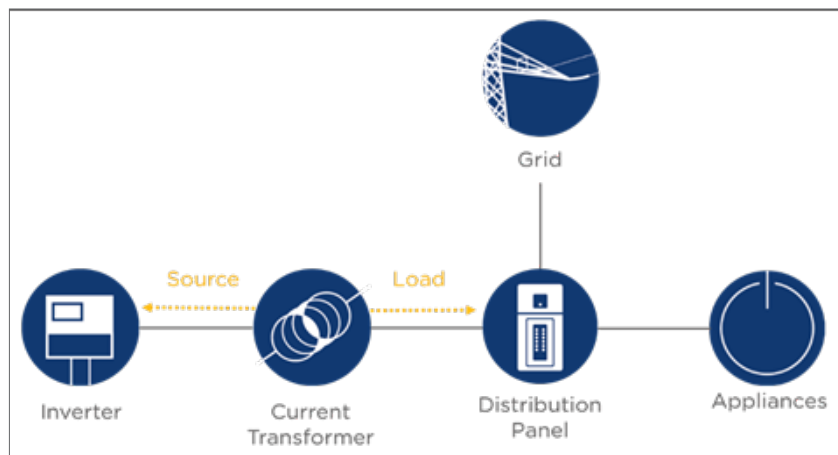

Figure A.2: PV Production Monitoring

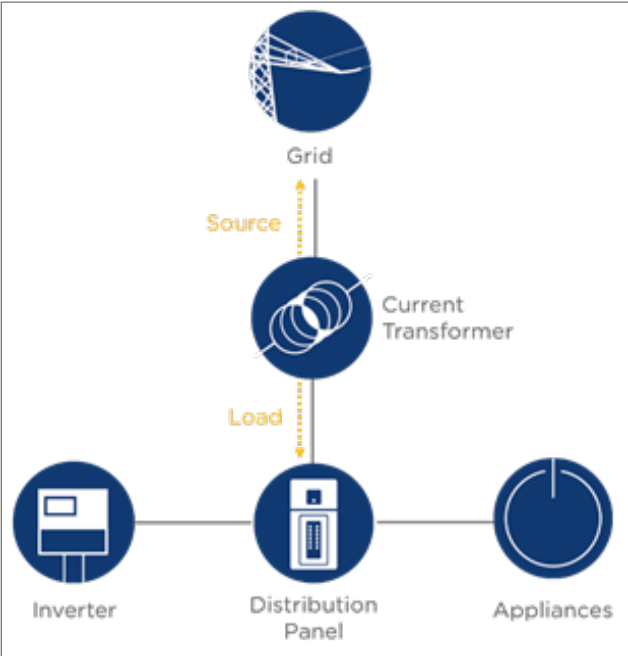

Figure A.3: Consumption (Grid Power & Bi-Directional) Monitoring & Net Export

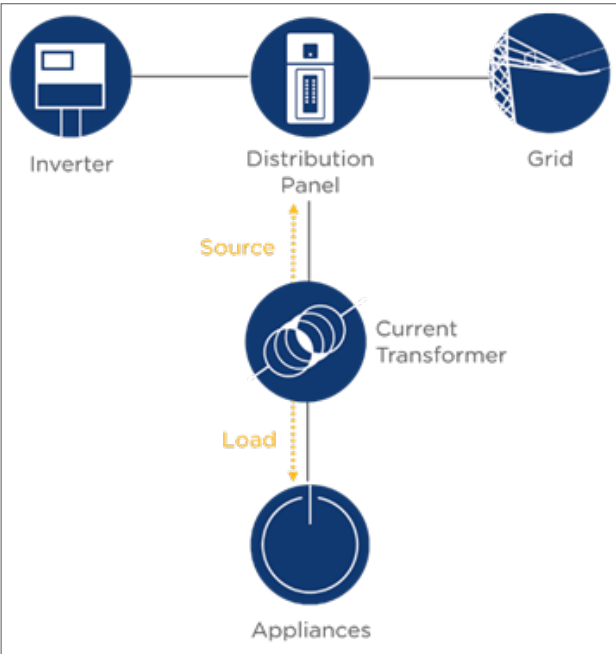

Figure A.4: Sub-consumption Monitoring

# Support

---

## Technical Support

For further support please visit the Service & Support tab at [www.Solar-Log-America.com](http://www.Solar-Log-America.com), call (203) 702-7189 option 2 to speak with a member of our technical support team or email the support team at [us.support@solar-log.com](mailto:us.support@solar-log.com)

